

# Youngest Play Big!

Play and Climbing Equipment for the Youngest.



Discover  
our brand new  
Products!

  
**Berliner**  
Play equipment for life

# Berliner Seilfabrik Play equipment for life

This slogan means a lot to us! It defines how we work and construct playgrounds. In our 50 years of experience in playground equipment, we have built up an extensive product range with creative ideas and industry expertise. We offer unforgettable, fascinating designs for all types of play, whether indoors or outdoors.



Berliner Seilfabrik  
Play Equipment Corporation  
96 Brookfield Oaks Drive  
Suite 140  
Greenville, SC 29607

T + 1 864 627 1092  
F + 1 864 627 1178

info@berliner-playequipment.com  
www.berliner-playequipment.com

## Our Play Functions

The early dexterity and psychomotor development is important for growing children. It is important to support toddlers and young kids in this area. Since the legal right to child care was established, the demand for play equipment that is suitable for young children, especially outdoors, has been growing via the new construction and expansion of child care facilities. The Berliner Seilfabrik has a wide range of play equipment in its portfolio that is explicitly oriented on the needs of children in the child-care age group. These

devices provide kids between the age of one to six a safe and comprehensive playing offer, in which they can train their social and motor skills.

Classic elements such as slides or swings are as in demand as the opportunities to include daily tasks such as climbing stairs, cooking, or shopping and selling. Our playground equipment for daycare facilities are characterized by the following features:



**5**  
Playhouses and Sensory Elements

Playhouses offer the ideal space for role-playing games. Language and social skills are promoted in a new playful way. Connected with sensory play elements, the receptivity and creativity is trained. More Information on page 5.

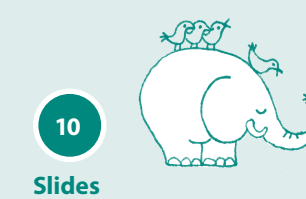

**10**  
Slides

The slides are built in a way that small kids can reach them without outside help. Sliding promotes spatial perception and improves the sense of balance and coordination. More Information on page 10.



**19**  
Climbing

Climbing in a spatial net offers the chance to gather initial experience in climbing in a three-dimensional space. This promotes spatial powers of imagination. Nets, ladders and steps offer different difficulty levels of climbing. More Information on page 19.



**27**  
Carousels

Merry-go-rounds with a low entry height allow even small children to play on their own. Turning with the help of play equipment generates a sensory stimulation that has a positive effect on balance and "sensing oneself", i.e. the own body awareness. More Information on page 27.



**31**  
Balancing and Dangling

Balancing on ropes, wobbly walking, crawling on rubber bridges or focused walks across a close-meshed net trains the sense of balance and prepares kids for the next developmental phases. Whether it's standing, walking, jumping or riding a bike. More Information on page 31.



**35**  
Swinging & Seesaw

Different swing seats and seesaw machinery ensure that kids in all development stages can enjoy the equipment. Swinging and seesawing develops the physical awareness and feeling well while simultaneously strengthens motor skills. More Information on page 35.



## Playhouses and Sensory Elements

# Today I am...!

- Playhouses offer the ideal space for role-playing games. Language and social skills such as empathy are developed in a playful way.
- In this way, children try out who they are or can be while simultaneously exploring challenges in dealing with others and master them while playing.
- The world of emotions is also provided space to be freely experienced.
- Playhouses can be ideally combined with sensory playing elements, but they also foster learning aptitude and creativity 'on their own'.
- Sensory playing elements form important neural and mental connections in the human brain. Our play equipment below takes this into account by using different and alternating surfaces and reactive materials, such as ropes or rubber membranes. This helps children to consciously perceive their surroundings.



## Wonderwalls.01

90.295.700.1

(m) 2,3 x 2,7 x 1,7  
('-") 7-7 x 8-11 x 5-4

EN 1176 (m) 5,3 x 5,7  
ASTM/CSA (m) 6,0 x 6,4  
ASTM/CSA ('-") 19-7 x 20-11

EN 1176 (m) 1,21  
ASTM/CSA ('-") 4-0

Playing in the undergrowth! The world of hedgehogs, mice and beetles starts here. Designed as a tree stump, the highlight of these Wonderwalls is the passage with rubber membranes connecting two play areas. And anyone looking closely will find a secret opening under the bench. Do you dare crawl through it?

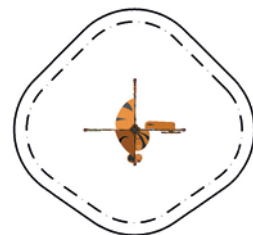
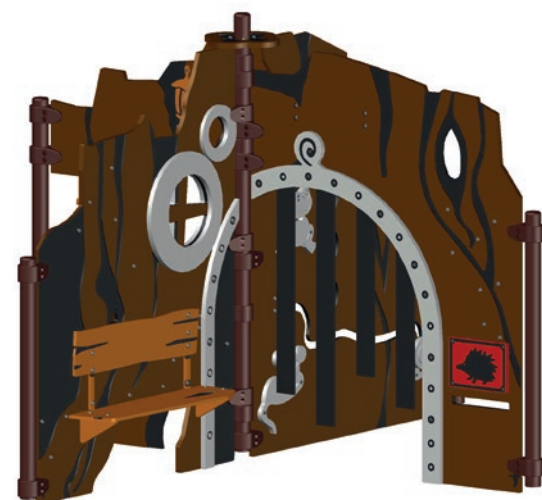

## Wonderwalls.03

90.295.700.3

(m) 3,3 x 2,4 x 1,6  
('-") 10-9 x 7-11 x 5-0

EN 1176 (m) 6,3 x 5,4  
ASTM/CSA (m) 6,9 x 6,1  
ASTM/CSA ('-") 22-9 x 19-11

EN 1176 (m) 1,24  
ASTM/CSA ('-") 4-10

Playing in the pumpkin house! An eerily fun play adventure invites the toddlers on a discovery tour into the world of wizards and witches. A jungle bridge with handrail rope encourages the first balancing attempts. To get to the memo-play, on one side a box has to be climbed first. Who dares to explore the cave?



New

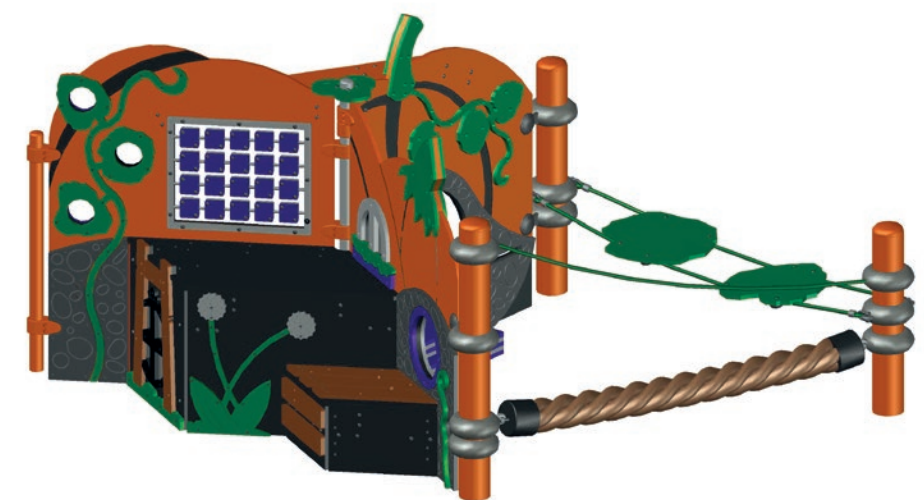

## Wonderwalls.02

90.295.700.2

(m) 5,0 x 2,7 x 1,7  
(") 16-5 x 8-11 x 5-6

EN 1176 (m) 8,0 x 5,7  
ASTM/CSA (m) 8,7 x 6,4  
ASTM/CSA (") 28-5 x 20-11

EN 1176 (m) 1,26  
ASTM/CSA (") 4-2

Playing under the mushroom! Toddlers can immerse themselves in the world of wonders and fables, like pixies. Play elements such as mud tables, hatches in the walls and a sand workshop inspire role play. A hammock made of rubber mats encourages the youngsters to swing or try their first walking and crawling experiences on shaky ground.

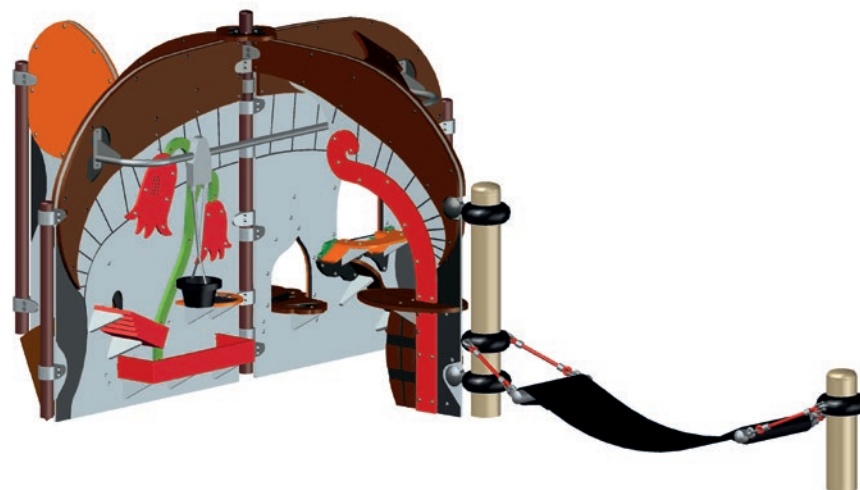
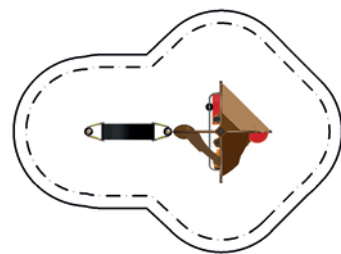

## Sand Workshop

96.180.094

(m) 1,3 x 4,8 x 3,2  
(") 4-0 x 5-10 x 10-3

EN 1176 (m) 4,3 x 4,8  
ASTM/CSA (m) 4,9 x 5,5  
ASTM/CSA (") 16-0 x 17-10

EN 1176 (m) 0,97  
ASTM/CSA (") 3-3

Whether it's a construction site, bakery or gravel plant, the bucket on the chain hoist of the sand workshop offers countless possibilities for role-playing games.



## Roo M.03

90.295.600.3

(m) 1,9 x 4,8 x 2,1  
 (") 6-3 x 15-7 x 6-10

EN 1176 (m) 4,9 x 8,3  
 ASTM/CSA (m) 5,6 x 8,4  
 ASTM/CSA (") 19-3 x 27-7

EN 1176 (m) 0,90  
 ASTM/CSA (") 3-0



Large haunted house Roo M.03 with ramp and slide in the color combination Erwin. Twin counters beneath the haunted house create another play area.



### Slides

- Sliding helps with spatial perception as the child has to judge the right moment to slide and when to place its feet on the ground for a proper landing.
- Sliding also improves the sense of balance and coordination skills, especially when children experiment with sliding backwards.

## Spoo S.01

90.295.000.1

(m) 2,0 x 2,3 x 2,2  
 (") 6-6 x 7-6 x 7-2

EN 1176 (m) 4,6 x 5,4  
 ASTM/CSA (m) 5,7 x 6,0  
 ASTM/CSA (") 18-6 x 19-7

EN 1176 (m) 0,45  
 ASTM/CSA (") 1-6

Spooky house Spoo S with stepladder, ramp and window.

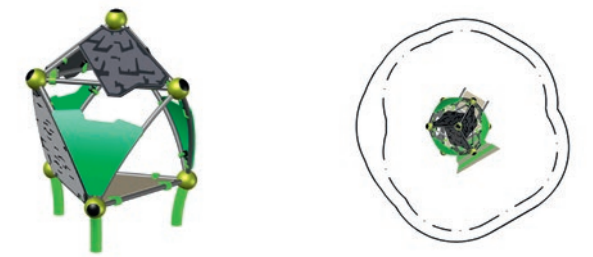

## Spoo M.01

90.295.100.1

(m) 3,6 x 2,4 x 2,7  
 (") 11-10 x 7-11 x 8-8

EN 1176 (m) 7,2 x 5,4  
 ASTM/CSA (m) 7,3 x 6,1  
 ASTM/CSA (") 24-0 x 20-0

EN 1176 (m) 0,90  
 ASTM/CSA (") 3-0

With a ramp and a slide this play house offers perfect fun for small children from 2 to 5.

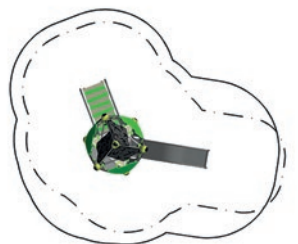

## Spooroo Combi.01

90.296.001

	(m)	6,5 x 5,8 x 2,7
	("-")	21-1 x 18-11 x 8-8
	EN 1176 (m)	9,8 x 8,9
	ASTM/CSA (m)	10,1 x 9,5
	ASTM/CSA ("-")	33-1 x 31-1
	EN 1176 (m)	0,90
	ASTM/CSA ("-")	3-0

A spooky house Spoo S with a ramp and a stepladder, a spooky house Roo S with a ladder and a Spoo M with a slide, all of them connected by suspension bridges.

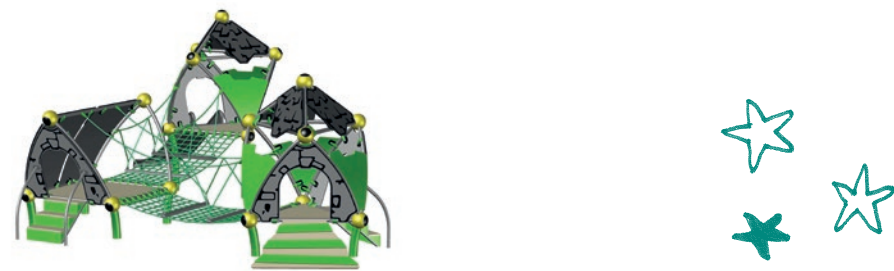
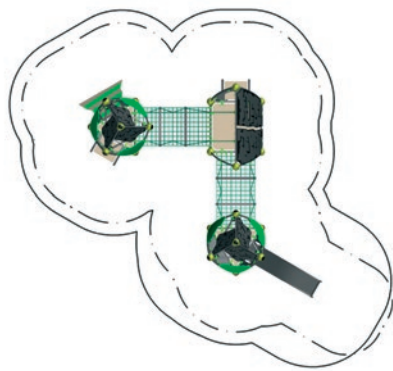

## Spooroo Combi.03

90.296.003

	(m)	2,3 x 6,9 x 2,2
	("-")	7-6 x 22-7 x 7-2
	EN 1176 (m)	5,4 x 10,5
	ASTM/CSA (m)	6,0 x 10,6
	ASTM/CSA ("-")	19-7 x 34-8
	EN 1176 (m)	0,90
	ASTM/CSA ("-")	3-0

A spooky house Spoo S with a ramp and a stepladder and a spooky house Roo M with a slide connected by a suspension bridge.

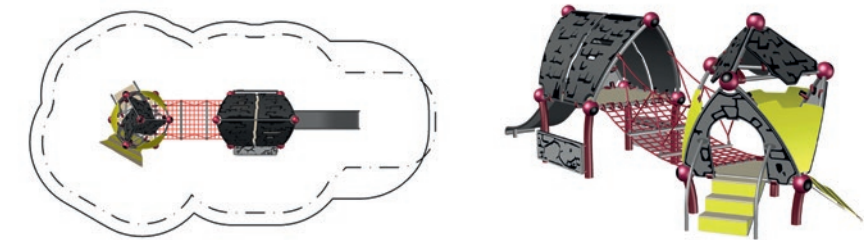

## Spooroo Combi.02

90.296.002

	(m)	1,9 x 3,3 x 2,2
	("-")	6-0 x 10-9 x 7-2
	EN 1176 (m)	4,9 x 6,3
	ASTM/CSA (m)	5,6 x 6,9
	ASTM/CSA ("-")	18-4 x 22-7
	EN 1176 (m)	0,45
	ASTM/CSA ("-")	1-6

A spooky house Spoo S with a ladder and a window linked directly to a spooky house Roo S with a ramp.

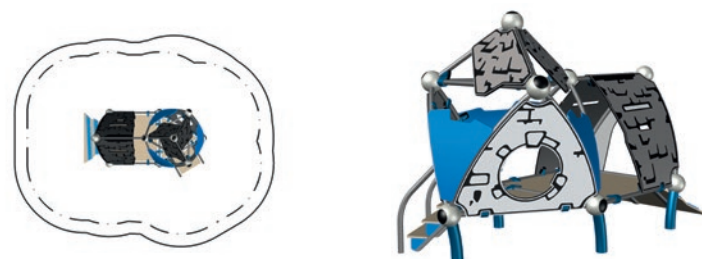

## Spooroo Combi.019

90.296.019

	(m)	2,4 x 7,2 x 2,2
	("-")	7-7 x 23-5 x 7-2
	EN 1176 (m)	5,4 x 10,7
	ASTM/CSA (m)	6,0 x 10,8
	ASTM/CSA ("-")	19-7 x 35-5
	EN 1176 (m)	0,90
	ASTM/CSA ("-")	3-0

The Spooroo Combi.019 adds a bit more speed to the slide. Furthermore, the new Fast Lane Slide fits perfectly into the spooky design thanks to its customizable Sidepanels.

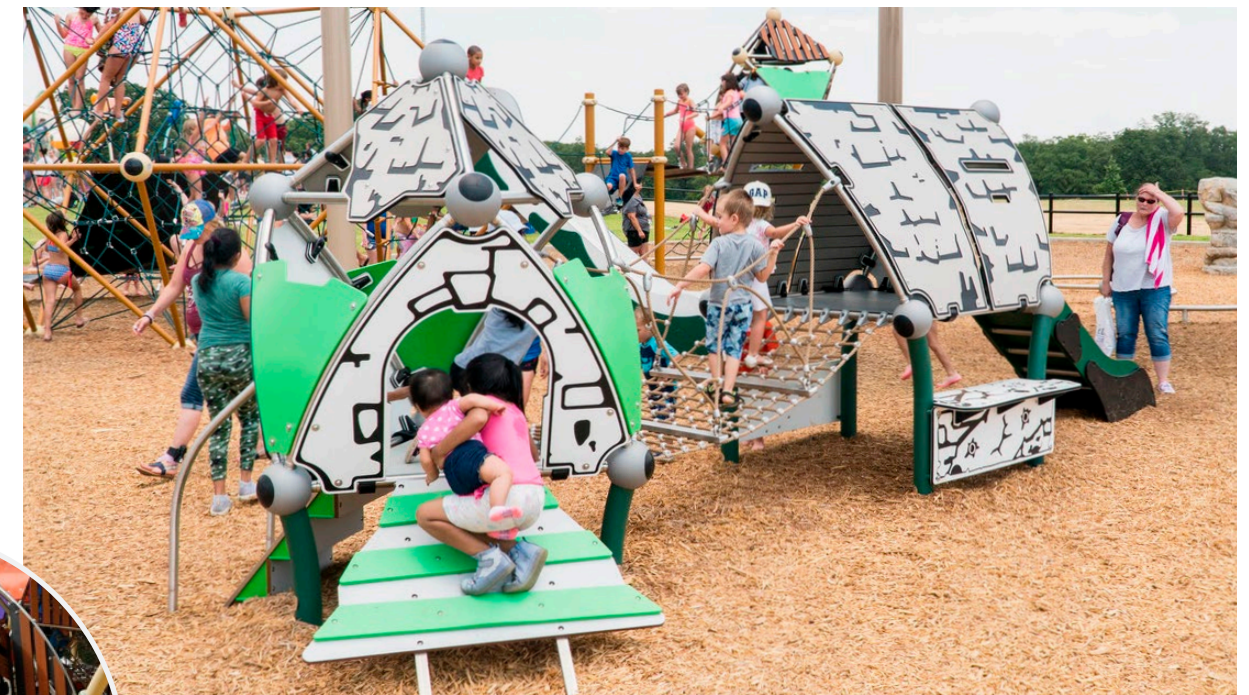



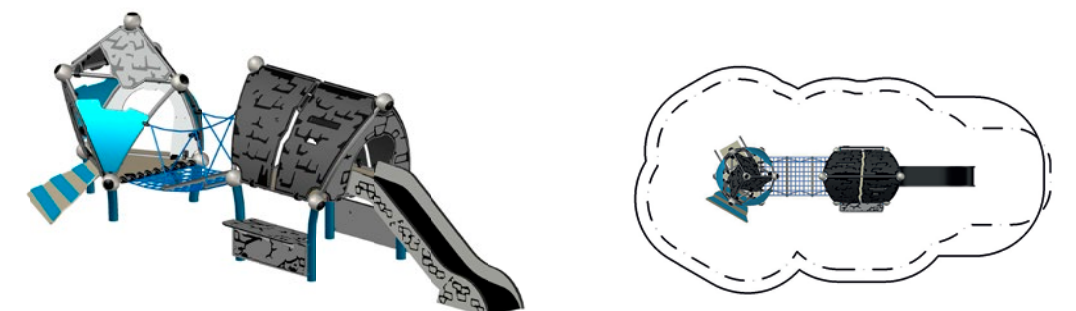



Discover our HDPE Fast Lane Slides!



## Combi.061

90.293.061





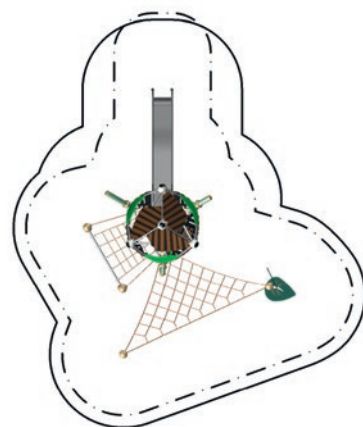

 (m)	5,7 x 7,2 x 3,2
 (-")	18-5 x 23-5 x 10-4
 EN 1176 (m)	8,7 x 10,7
 ASTM/CSA (m)	9,3 x 10,8
 ASTM/CSA (-")	30-5 x 35-5
 EN 1176 (m)	0,99
 ASTM/CSA (-")	3-3

This small Trii-Combi is particularly charming. In addition to the ladder and slide, a climbing net leads to a mud table, which appeals in particular to a playground's youngest users.



## Combi.102

90.293.102





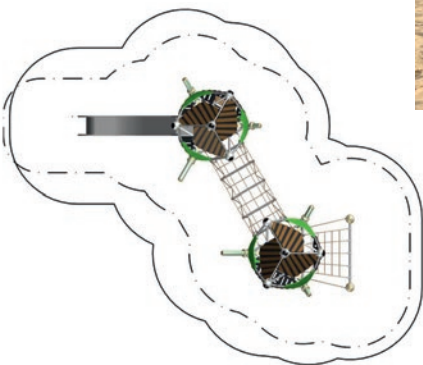

 (m)	7,5 x 6,0 x 3,2
 (-")	24-5 x 19-6 x 10-4
 EN 1176 (m)	11,0 x 8,5
 ASTM/CSA (m)	11,1 x 9,6
 ASTM/CSA (-")	36-5 x 31-6
 EN 1176 (m)	0,99
 ASTM/CSA (-")	3-3

These Trii combinations set the hearts of tiny tots racing. The Triis can be linked to each other via a bridge.



## Combi.362

90.293.362





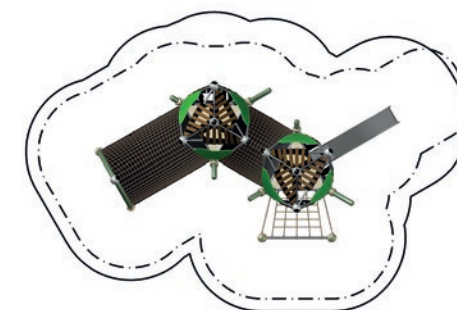

 (m)	4,3 x 8,1 x 3,2
 (-")	13-11 x 26-4 x 10-4
 EN 1176 (m)	6,8 x 11,5
 ASTM/CSA (m)	7,9 x 11,8
 ASTM/CSA (-")	25-11 x 38-5
 EN 1176 (m)	0,99
 ASTM/CSA (-")	3-3

A ramp from the boundary wall offers direct climbing access to this Greenville Combi, composed of two Trii1s and net tunnels. This ensures the play equipment blends perfectly into its surroundings, offering small children in particular ample room for independent play. As well as this, rope ladders, an access net and a slide offer enticing challenges for the little ones.



## Boo

90.280.000

 (m)	3,1 x 3,0 x 2,6
 (-")	10-1 x 9-8 x 8-4
 EN 1176 (m)	6,1 x 6,0
 ASTM/CSA (m)	6,8 x 6,6
 ASTM/CSA (-")	22-1 x 21-8
 EN 1176 (m)	1,53
 ASTM/CSA (-")	6-0

In this small rope play house with a space net and bamboo panels, the children will experience the benefits of spatial nets and at the same time enjoy the coziness of playhouses.

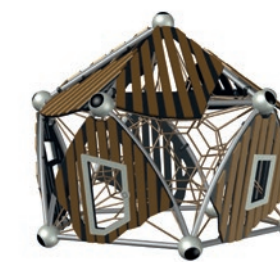
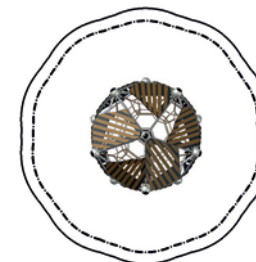





## Woodville Combi.17

90.224.101.7

(m) 5,2 x 7,1 x 3,0  
(ft) 16-11 x 23-3 x 9-10

EN 1176 (m) 8,2 x 10,6  
ASTM/CSA (m) 8,8 x 10,8  
ASTM/CSA (ft) 28-11 x 35-3

EN 1176 (m) 0,90  
ASTM/CSA (ft) 3-0

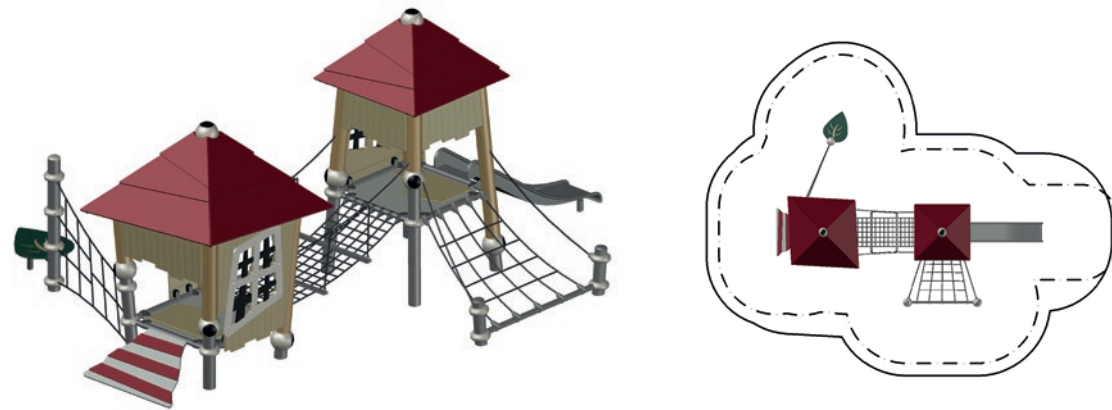

This Woodville combination is ideal for toddlers thanks to its low access height. Various climbing elements such as a planar net, a rope ladder and a ramp offer different levels of climbing difficulty. The suspension bridge is a special highlight. The little ones can test and train their sense of balance here.

## Quoo

98.150.001

(m) 1,4 x 1,4 x 2,3  
(ft) 4-8 x 4-8 x 7-5

EN 1176 (m) 4,4 x 4,4  
ASTM/CSA (m) 5,1 x 5,1  
ASTM/CSA (ft) 16-8 x 16-8

EN 1176 (m) 1,30  
ASTM/CSA (ft) 4-4

This earthy play house combines imaginative play with climbing. Thanks to the bamboo, it may also serve as a cool retreat on hot summer days.



## Wam

90.300.003

(m) 2,0 x 2,0 x 2,4  
(ft) 6,4 x 6,4 x 7-11

EN 1176 (m) 5,0 x 5,0  
ASTM/CSA (m) 5,6 x 5,6  
ASTM/CSA (ft) 18-4 x 18-4

EN 1176 (m) 0,22  
ASTM/CSA (ft) 0-9

A small playhouse equipped with bamboo panels, the wigwam offers a lot of fun for the youngest.

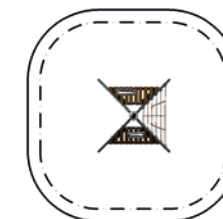



## Climbing

# Climbing makes you **strong and smart!**

- Climbing in spatial nets especially promotes three-dimensional imagination.
- Climbing in a three-dimensional space promotes the development of motor planning and motor control. This includes the detection of the movement position of the body in space or on the play equipment and the resulting necessary coordinated movements.
- Climbing sharpens visual perception and motor skills when children need to decide where to place a foot or hand to move up or down.
- Climbing increases muscle tone and strength for both fine and coarse motor movements.
- Climbing excellently trains the sense of balance.
- Climbing develops motor fitness such as agility, speed, coordination and balance.
- Problem solving and decision-making skills are improved by climbing.





## Cosmo S.05

90.111.050

 (m) 4,6 x 4,5 x 2,9  
 ("'-") 15-1 x 14-8 x 9-6

 EN 1176 (m) 7,8 x 7,8  
 ASTM/CSA (m) 8,3 x 8,2  
 ASTM/CSA ("'-") 27-1 x 26-11

 EN 1176 (m) 1,80  
 ASTM/CSA ("'-") 6-0



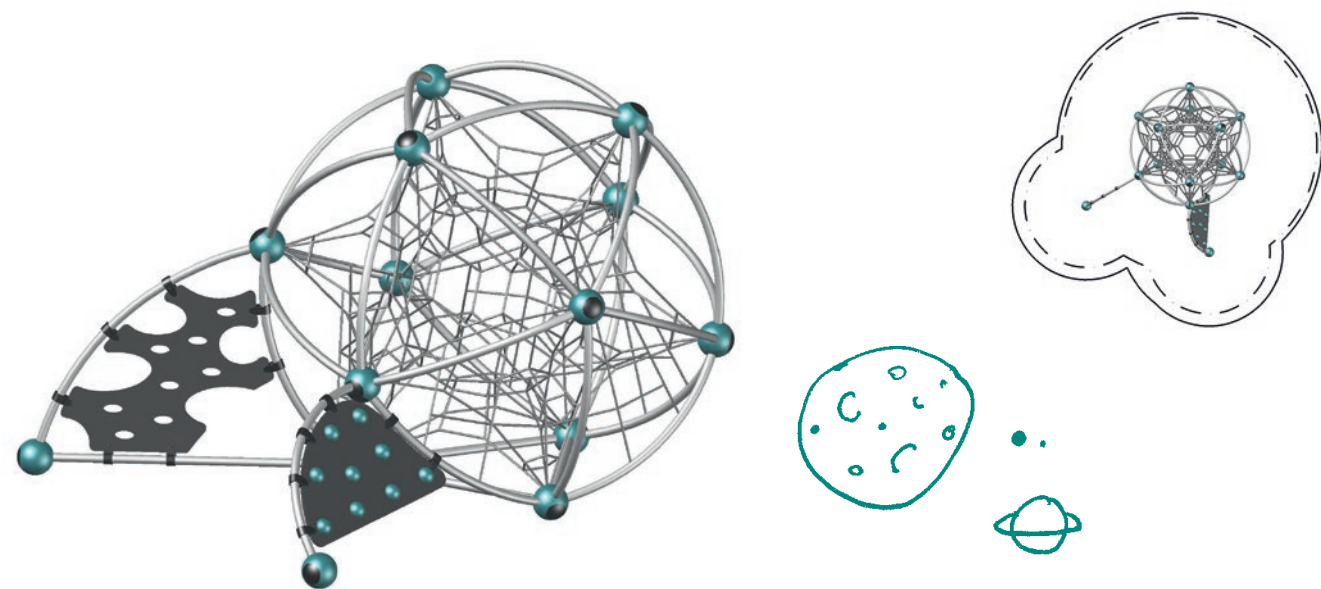

With its climbing ramp and climbing wall, the Cosmo S.05 is perfectly equipped for whole groups of children who love climbing.





## Cosmo.S04

90.111.040

 (m) 5,7 x 4,6 x 2,9  
 ("'-") 18-9 x 15-1 x 9-6

 EN 1176 (m) 8,8 x 7,8  
 ASTM/CSA (m) 9,4 x 8,3  
 ASTM/CSA ("'-") 30-9 x 27-1

 EN 1176 (m) 1,80  
 ASTM/CSA ("'-") 6-0

The Cosmo S.04 is only one possibility of combining the Cosmo S base with add-on elements: a climbing wall, a climbing ramp and a net wall make this small Cosmo the highlight on every playground.

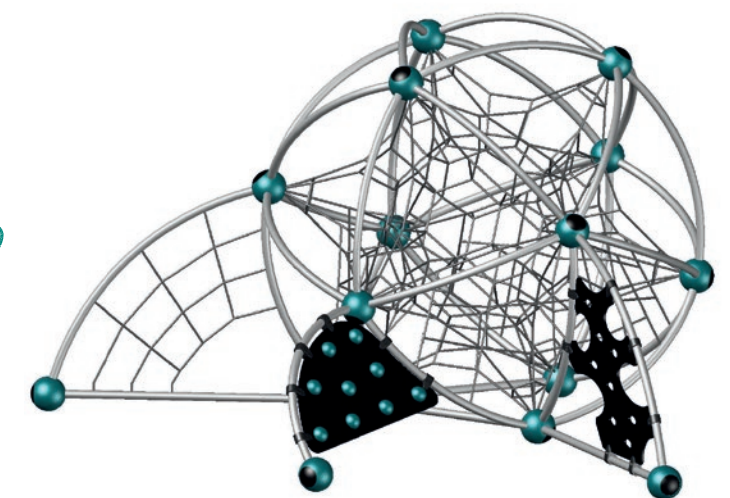

## Twist.03

**90.297.003**

(m) 2,4 x 5,8 x 2,7  
 (") 7-10 x 19-0 x 8-8

EN 1176 (m) 5,4 x 8,8  
 ASTM/CSA (m) 6,1 x 9,5  
 ASTM/CSA (") 19-10 x 31-0

EN 1176 (m) 2,57  
 ASTM/CSA (") 8-6

This smaller-sized incarnation of the Twist & Shout range of play equipment offers all sorts of climbing fun, including the possibility of climbing almost 10 feet into the air. Twist.03 will enhance every open space it is placed in.

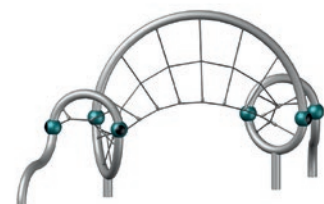
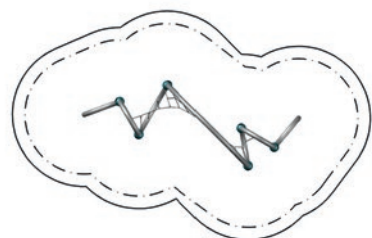

## UFO.M3

**90.220.030**

(m) 5,0 x 5,7 x 2,2  
 (") 16-2 x 18-7 x 7-0

EN 1176 (m) 8,0 x 8,7  
 ASTM/CSA (m) 8,6 x 9,4  
 ASTM/CSA (") 28-2 x 30-7

EN 1176 (m) 1,93  
 ASTM/CSA (") 6-4

The version with three modules is a great challenge for little climbers.

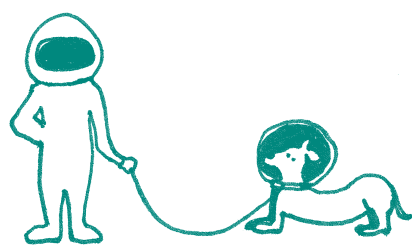
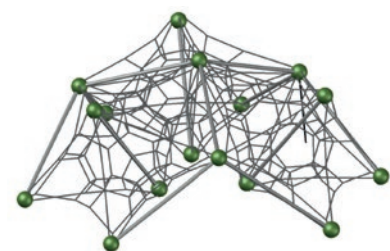
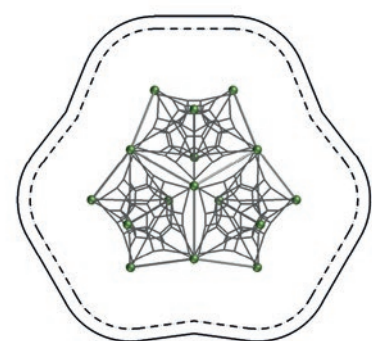

## Pentagode S

**91.200.010**

(m) 8,4 x 8,0 x 4,0  
 (") 27-4 x 26-0 x 13-2

EN 1176 (m) 11,4 x 11,0  
 ASTM/CSA (m) 12,0 x 11,6  
 ASTM/CSA (") 39-4 x 38-0

EN 1176 (m) 0,93  
 ASTM/CSA (") 6-0

Even the smallest 13' high Pentagode has plenty of room for lots of kids to play. There is loads of room at the top for the more adventurous!

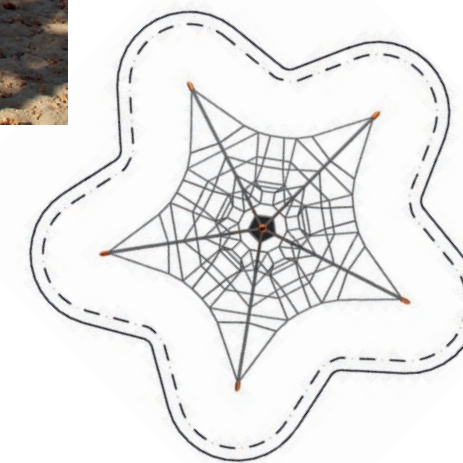

## Spaceball S

**90.100.031**

(m) 3,7 x 3,7 x 3,0  
 (") 11-11 x 11-11 x 9-11

EN 1176 (m) 6,7 x 6,7  
 ASTM/CSA (m) 7,3 x 7,3  
 ASTM/CSA (") 23-11 x 23-11





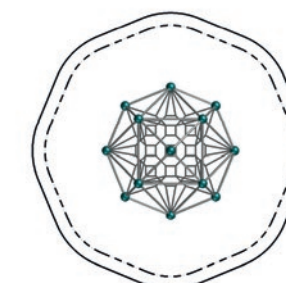
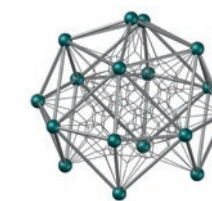
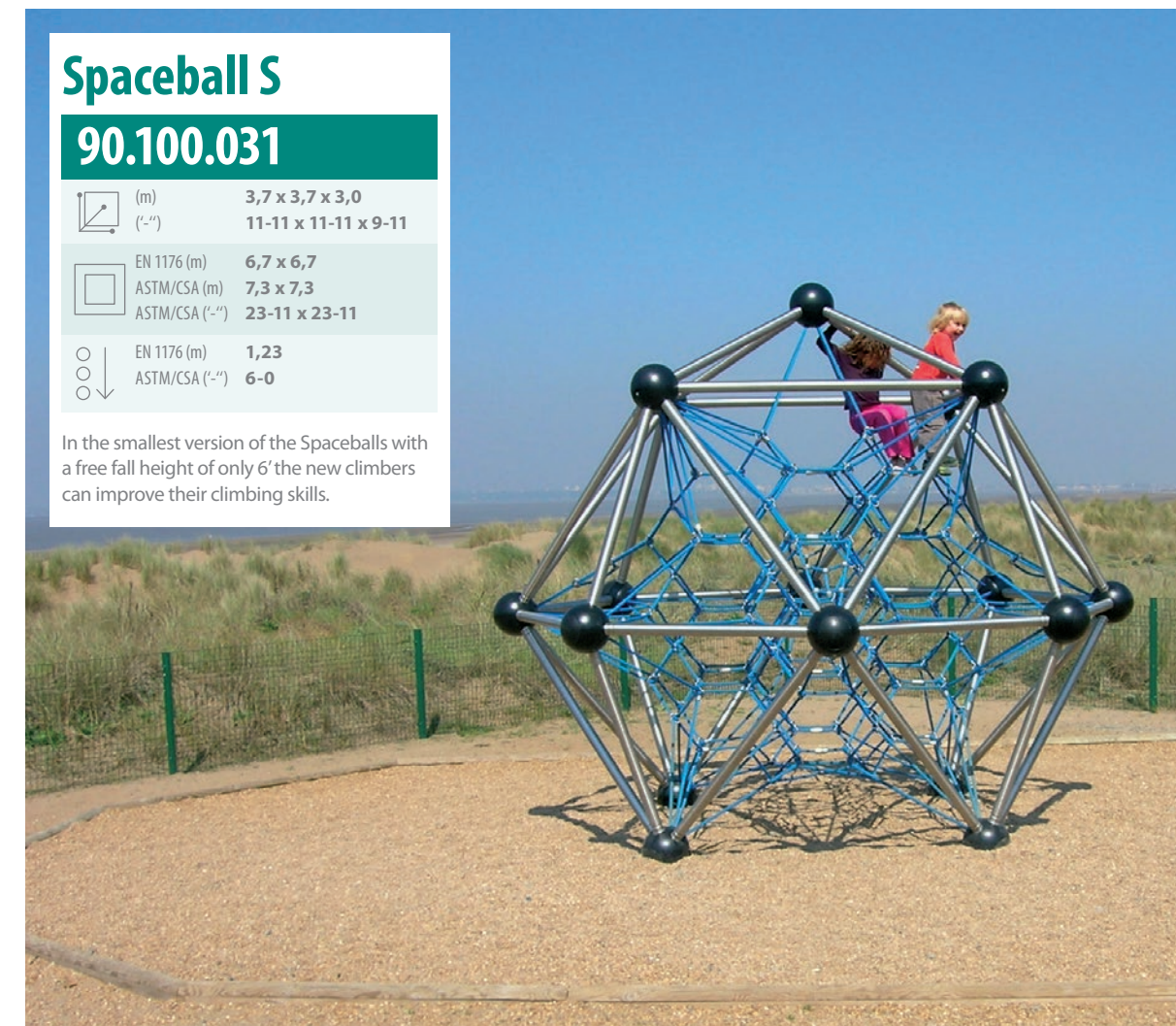

EN 1176 (m) 1,23  
 ASTM/CSA (") 6-0

In the smallest version of the Spaceballs with a free fall height of only 6' the new climbers can improve their climbing skills.



## Net House.02

90.130.003





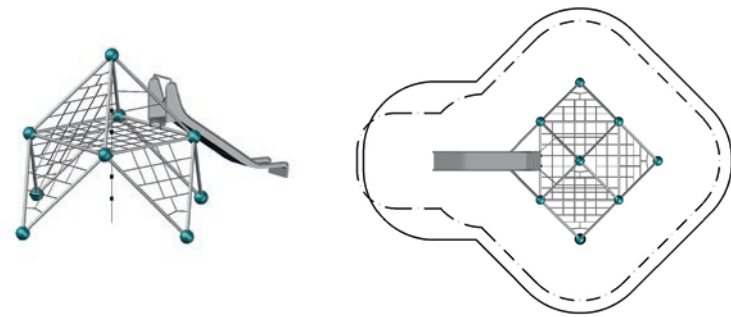

 (m)	6,1 x 4,4 x 3,0
 (-")	19,11 x 14-5 x 9-7
 EN 1176 (m)	9,6 x 7,4
 ASTM/CSA (m)	8,1 x 9,8
 ASTM/CSA (-")	31-11 x 26-5
 EN 1176 (m)	1,34
 ASTM/CSA (-")	4-5

Six triangular nets and a net platform turn the frame of a Mars structure into a net house. In combination with the central climbing rope and the slide the combination is a challenging play structure ideal for small spaces.



## Fairview.02

90.180.609







 (m)	4,3 x 8,1 x 3,4
 (-")	12-10 x 26-4 x 10-11
 EN 1176 (m)	7,5 x 11,3
 ASTM/CSA (m)	7,9 x 11,7
 ASTM/CSA (-")	25-11 x 38-4
 EN 1176 (m)	1,20
 ASTM/CSA (-")	6-0

The Mini Mars is specifically designed for beginners, as most of the usable netspace is close to the ground. Slide, rubber mat, play panel and horizontal bar are perfect additions.



## Mini Mars

98.100.010





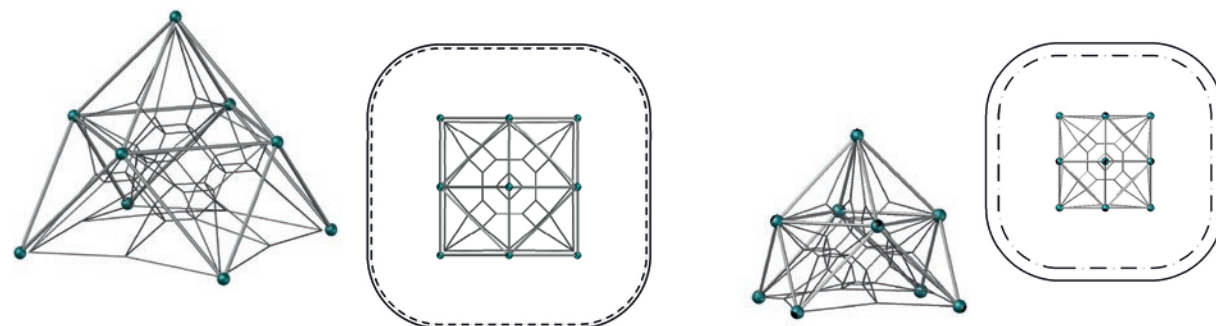

 (m)	2,6 x 2,6 x 2,4
 (-")	8-7 x 8-7 x 7-11
 EN 1176 (m)	5,6 x 5,6
 ASTM/CSA (m)	6,3 x 6,3
 ASTM/CSA (-")	20-7 x 20-7
 EN 1176 (m)	1,10
 ASTM/CSA (-")	6-0

The Mini Mars is the net structure for beginners. With the utilization of the downsized FrameworkX 48-system it is the ideal play structure for preschools.



## Fairview.01

90.180.608

 (m)	6,5 x 7,0 x 2,7
 (-")	21-1 x 22-11 x 8-8
 EN 1176 (m)	9,8 x 10,3
 ASTM/CSA (m)	10,1 x 11,0
 ASTM/CSA (-")	33-1 x 36-1
 EN 1176 (m)	1,13
 ASTM/CSA (-")	6-0

This combination of Spoo, Mini Mars and Hammock offers uncountable possibilities of climbing, relaxing and swinging for small children.

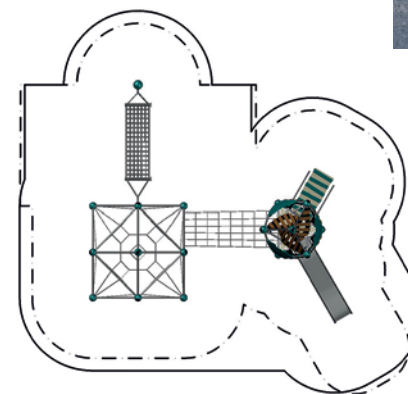
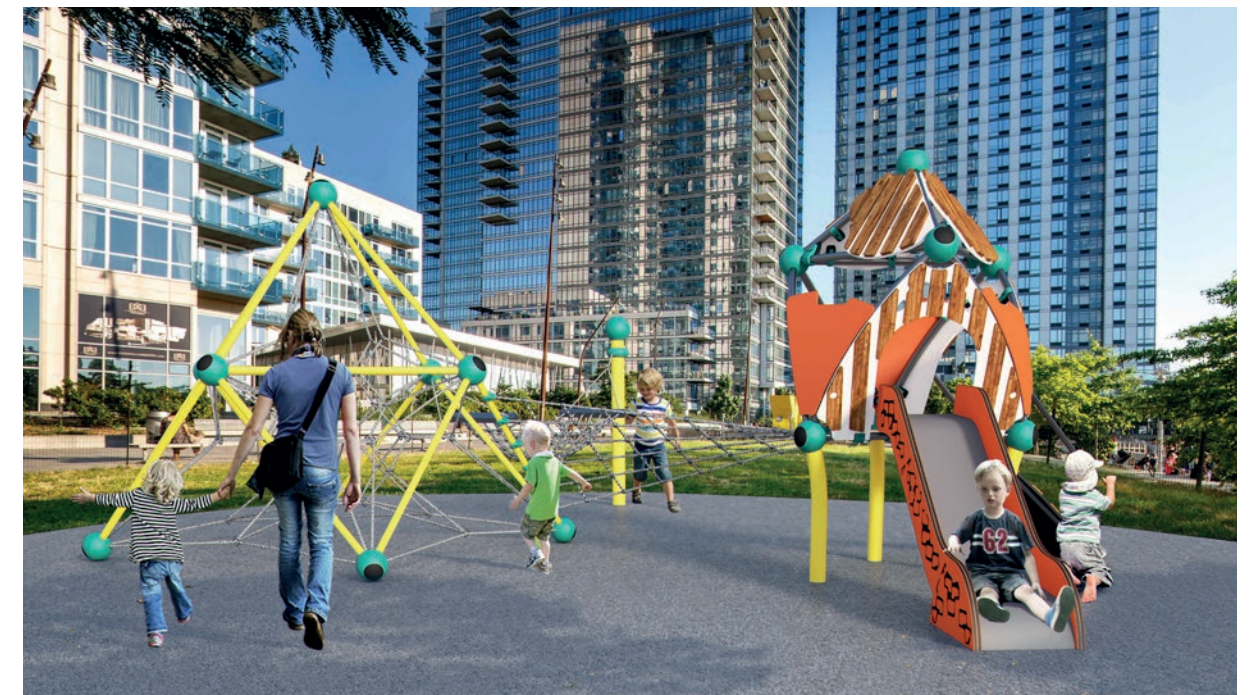



## Carousels

# Development Booster: Spinning

- Spinning generates a sensory stimulation which has a positive effect on balance and body perception.
- Carousels promote posture control, i.e. the ability to remain upright despite shifting gravity.
- Carousels also positively influence social behavior. Interacting with other children often becomes necessary to boost each other or to ride together.
- Spinning strengthens muscle strength and stamina.
- The kinesthetic consciousness (knowing where the body is in space) is strengthened by learning to avoid falling down or colliding with other playmates.
- Spinning also trains the decision-making skills of children as they have to think during the quick movements.



## Access Whirl

90.261.200

(m) 1,3 x 1,0 x 1,0  
(ft) 4-1 x 3-7 x 3-4

EN 1176 (m) 5,3 x 5,3  
ASTM/CSA (m) 4,9 x 4,9  
ASTM/CSA (ft) 16-1 x 16-1

EN 1176 (m) 1,00  
ASTM/CSA (ft) 1-5

The Access Whirl is unique in the market. The product is easily accessible and children have great support and grip because of the net structure. The shape provides a safe cocoon so that children are more secure when the product spins around.

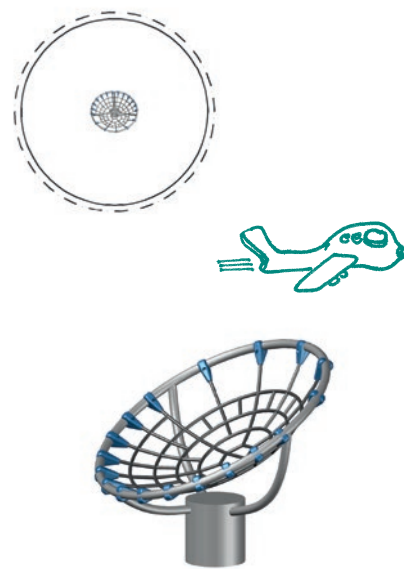

## Eddie.04

90.260.104

(m) 0,5 x 0,5 x 0,9  
(ft) 1-8 x 1-8 x 3-0

EN 1176 (m) 3,5 x 3,5  
ASTM/CSA (m) 4,2 x 4,2  
ASTM/CSA (ft) 13-8 x 13-8

EN 1176 (m) 0,40  
ASTM/CSA (ft) 1-2

The Eddie.04 is another shorty, but it stands slanted and its stainless steel stem is curved. Very stylish! It offers a nice little spin for the youngsters.

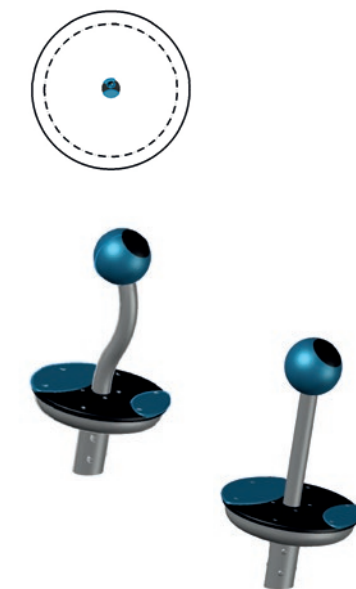

Eddie.03  
90.260.103

## Little Big Ben 2.2

90.260.305

(m) 1,3 x 1,3 x 0,8  
(ft) 4-1 x 4-1 x 2-6

EN 1176 (m) 5,3 x 5,3  
ASTM/CSA (m) 4,9 x 4,9  
ASTM/CSA (ft) 16-1 x 16-1

EN 1176 (m) 0,8  
ASTM/CSA (ft) 2-6

A ride on Little Big Ben is an extraordinary experience. Children can influence the speed by playing together. Each ride becomes a unique adventure.

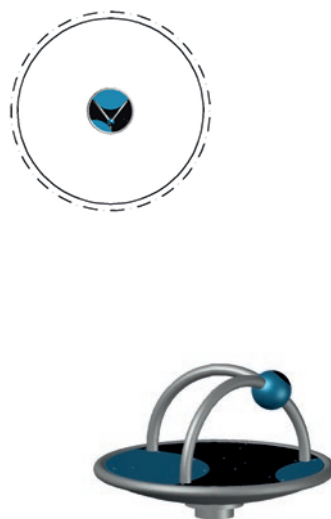

## O'Tannebaum 2.5

90.340.045

(m) 2,1 x 2,1 x 2,5  
(ft) 6-9 x 6-9 x 8-3

EN 1176 (m) 5,1 x 5,1  
ASTM/CSA (m) 5,7 x 5,7  
ASTM/CSA (ft) 18-9 x 18-9

EN 1176 (m) 0,50  
ASTM/CSA (ft) 1-8

A Christmas tree for all year round. Except for the trunk the entire tree is rotatable. The big rubber membrane surface with its low access height enables children with special needs also to join the fun.

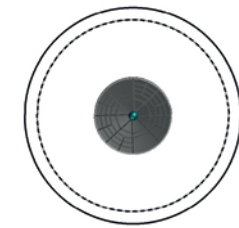
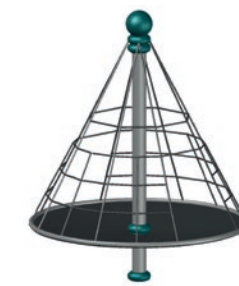

## O'Tannebaum 3.1

90.340.097

(m) 2,1 x 2,1 x 3,1  
(ft) 6-10 x 6-10 x 10-3

EN 1176 (m) 5,1 x 5,1  
ASTM/CSA (m) 5,7 x 5,7  
ASTM/CSA (ft) 18-9 x 18-9

EN 1176 (m) 0,50  
ASTM/CSA (ft) 1-8

The big brother of the O'Tannebaum.

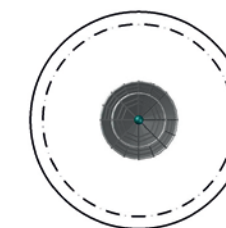

O'Tannebaum



## Albero.10

95.200.100

(m) 1,7 x 1,7 x 1,8  
(ft) 5-5 x 5-5 x 5-9

EN 1176 (m) 4,7 x 4,7  
ASTM/CSA (m) 5,4 x 5,4  
ASTM/CSA (ft) 17-5 x 17-5

EN 1176 (m) 1,00  
ASTM/CSA (ft) 3-4

The perfect merry-go-round for the youngest! Thanks to its transparent structure, this playpoint provides ease of supervision.

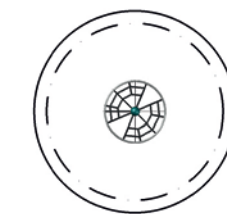

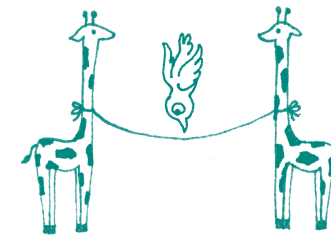

## Balancing and Layback

# Here come the Artists!

- Balancing on ropes, nets or bridges with rubber membranes trains their balance and body perception and thus supports the next developmental step, whether it's standing, running, jumping or cycling.
- Stamina and muscle strength are built when balancing by activating deep muscles. This allows children to work on improvement towards a healthy posture.
- Balancing and dangling requires skills such as perception, planning, risk assessment, decision-making and reaction that all need to alternate quickly. This especially promotes coordination and concentration.
- By playing together on a balancing pole, rope or rubber membrane, children learn to be considerate, help others or spot each other. This promotes the kids' social competence in a playful way
- Hanging and balancing clarify essential physical relationships, such as the effect of gravity, balance or counterweight.







## Terranova.104

96.180.104

(m) 8,6 x 8,2 x 2,9  
('-") 28-0 x 26-9 x 9-6

EN 1176 (m) 11,6 x 11,2  
ASTM/CSA (m) 12,2 x 11,8  
ASTM/CSA ('-") 40-0 x 38-9

EN 1176 (m) 1,23  
ASTM/CSA ('-") 4-1

This apparatus incorporates and interconnects low-level climbing elements. Conceived for nursery children, it's already proving a hit in the small children's section of one of Berlin's largest playgrounds.

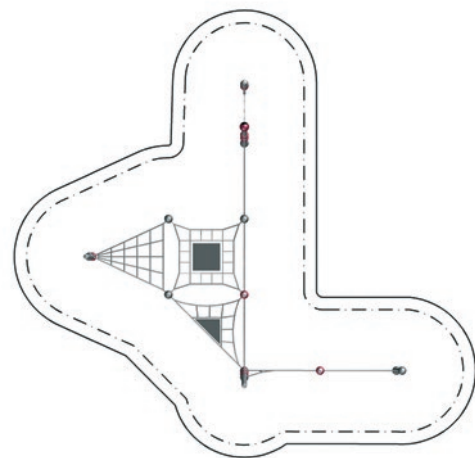
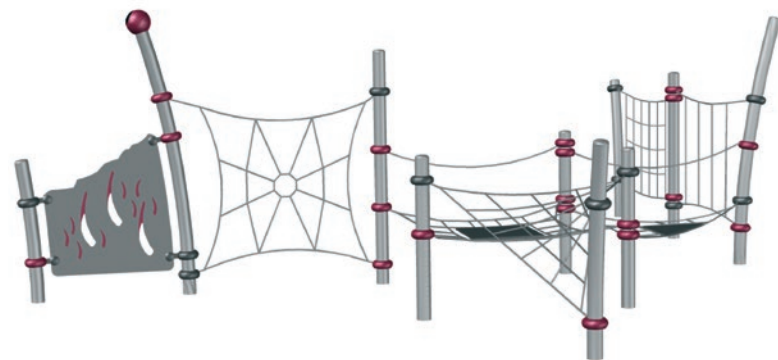

## Orbit.01

90.160.210.000.01

(m) 3,1 x 1,8 x 0,3  
('-") 10-0 x 5-10 x 0-10

EN 1176 (m) 6,1 x 4,8  
ASTM/CSA (m) 6,7 x 5,5  
ASTM/CSA ('-") 22-0 x 17-11

EN 1176 (m) 0,30  
ASTM/CSA ('-") 0-10

The Orbit.01 is a curvy balancing trail. Children love to balance and even adults will appreciate a quick balancing exercise.

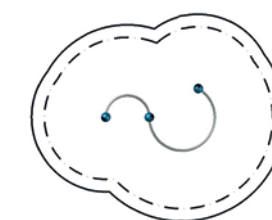

## Orbit.02

90.160.210.000.02

(m) 1,8 x 4,7 x 0,3  
('-") 5-10 x 15-5 x 0-10

EN 1176 (m) 4,8 x 7,7  
ASTM/CSA (m) 5,5 x 8,4  
ASTM/CSA ('-") 17-11 x 27-5

EN 1176 (m) 0,25  
ASTM/CSA ('-") 0-10

The Orbit.02 has one curve more than the Orbit.01. For those who like having a longer balancing challenge from one end to the other.

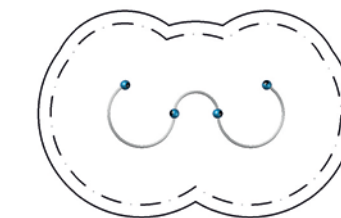

## Champignon.40

90.160.224

(m) 0,2 x 0,2 x 0,4  
('-") 0-8 x 0-8 x 1-4

EN 1176 (m) 3,2 x 3,2  
ASTM/CSA (m) 3,9 x 3,9  
ASTM/CSA ('-") 12-8 x 12-8

EN 1176 (m) 0,40  
ASTM/CSA ('-") 1-4

The Champignon is made for the good old leapfrog game. The Champignon.40 is the shortest of the three versions.

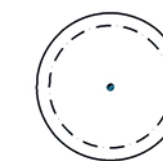



## Swinging & Seesawing

# Dynamic Development Support!

- Swings and seesaws develop the body sense and consciousness in a special way.
- Swinging develops the child's vestibular system, i.e. the ability to coordinate body movements, eye movements and balance.
- Muscle strength is built up, especially in the arms, legs and core.
- Swinging supports the development of motor planning and motor control, as is the case with climbing. This includes the detection of the movement position of the body in space or on the play equipment and the resulting necessary coordinated movements.
- Children experience the principle of cause and effect like 'What comes up must come down again' or 'If I let go or jump at this height, I would land hard and hurt myself.'
- Different swing seats ensure that children have the possibility to swing regardless of their developmental stage.
- The different seesaw equipment and the varying challenges to get it moving, give children at different developmental levels the opportunity to gain their own experiences in seesawing and bouncing.



## Arch Swing

90.260.534

(m) 1,3 x 3,2 x 3,0  
(") 4-2 x 10-4 x 9-10

EN 1176 (m) 6,8 x 3,2  
ASTM/CSA (m) 7,0 x 6,9  
ASTM/CSA (") 22-11 x 22-6

EN 1176 (m) 1,70  
ASTM/CSA (") 5-9

Elegant and practical! Suspended from a tubular arch, the Arch Swing has enough room for many children to enjoy swinging simultaneously. Not only that, it has an elegant design too.



## Bowl Swing

90.260.532

(m) 1,3 x 3,2 x 2,8  
(") 4-2 x 10-7 x 9-3

EN 1176 (m) 6,7 x 3,2  
ASTM/CSA (m) 7,0 x 6,9  
ASTM/CSA (") 22-10 x 22-6

EN 1176 (m) 1,70  
ASTM/CSA (") 5-9

Thanks to its low access height the Bowl Swing, just like the Cup Swing, is perfectly suited for toddlers or children with limited mobility.

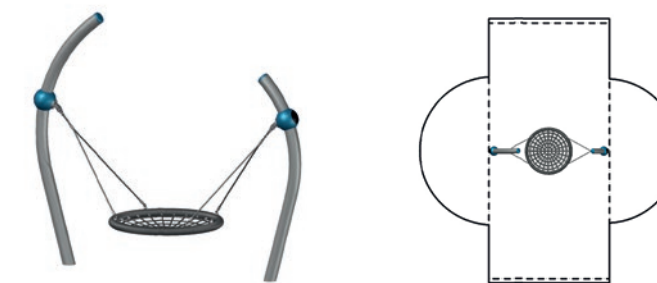

## Net Swing

90.260.533

(m) 0,7 x 3,8 x 2,9  
(") 2-0 x 12-3 x 9-3

EN 1176 (m) 6,6 x 3,2  
ASTM/CSA (m) 7,0 x 7,4  
ASTM/CSA (") 22-11 x 24-3

EN 1176 (m) 1,75  
ASTM/CSA (") 5-9

Relax and looking great at the same time! The organic looks of the bent posts in combination with the colorful balls make the Net Swing an optical highlight of urban areas.

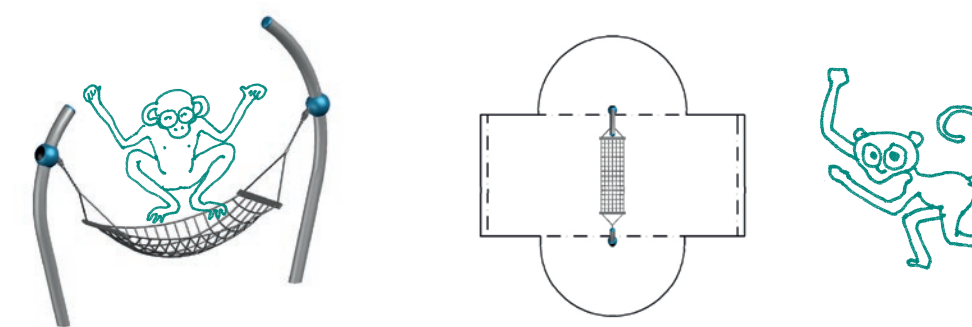

## Palmetto Saucer

95.190.578

3-4 x 9-7 x 6-11

ASTM/CSA (m) 6,1 x 6,6  
ASTM/CSA ("") 19-11 x 21-7

ASTM/CSA ("") 4-10

As an accessible multi-user swing, the Palmetto Saucer convinces through sharing fun. Heavy-duty engineering concealed behind a subtle, though striking design.



## Palmetto Twins

95.190.579

18-6 x 3-4 x 6-11

ASTM/CSA (m) 9,3 x 6,1  
ASTM/CSA ("") 30-6 x 19-11

ASTM/CSA ("") 4-9

What's better than one Palmetto? Two Palmettos! This combination of two nest swings offer plenty of space to swing.



## Palmetto Basket

90.340.071

(m) 0,3 x 1,9 x 2,2  
("") 1-0 x 6-1 x 7-0

EN 1176 (m) 6,5 x 1,9  
ASTM/CSA (m) 6-2 x 5,6  
ASTM/CSA ("") 20-2 x 18-1

EN 1176 (m) 0,97  
ASTM/CSA ("") 3-2

In this smaller version of the Palmetto Saucer, a swing seat especially for the smallest users has been suspended between slanting posts. This enables even the youngest of children to enjoy a safe swinging experience.

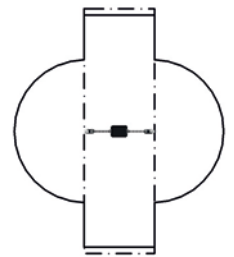

## Swingo.2.2

90.260.502

(m) 1,7 x 3,8 x 2,5  
("") 5-7 x 12-4 x 8-0

EN 1176 (m) 7,2 x 3,8  
ASTM/CSA (m) 8,0 x 7,5  
ASTM/CSA ("") 26-1 x 24-4

EN 1176 (m) 1,30  
ASTM/CSA ("") 6-7

The two-bay version of the smaller Swingos is asymmetrical, looks cool and doesn't keep the two users from going to and from in harmony.

The direct connection of two Swingo 2.2 allows rocking experiences for four children at the same time. Different seats are available.



Different seats available!

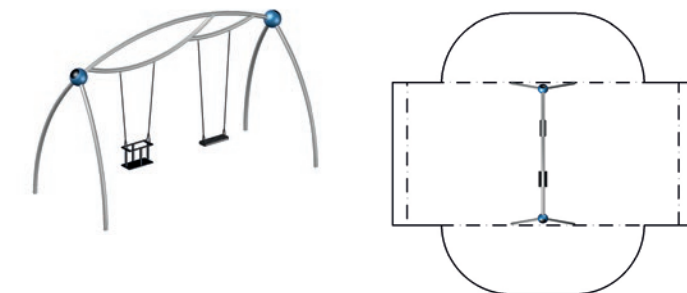

## Beetle.01

90.260.614.1

(m) 0,4 x 1,0 x 0,4  
("-") 1-4 x 3-2 x 1-4

EN 1176 (m) 2,4 x 3,0  
ASTM/CSA (m) 4,1 x 4,7  
ASTM/CSA ("-") 13-4 x 15-2

EN 1176 (m) 0,4  
ASTM/CSA ("-") 1-4



Beetle.01 impresses with its elegant design and technical superiority. A special rubber bearing element prevents a hard stop and thus ensures a smooth rocking experience. Here it goes quickly to the right and left!

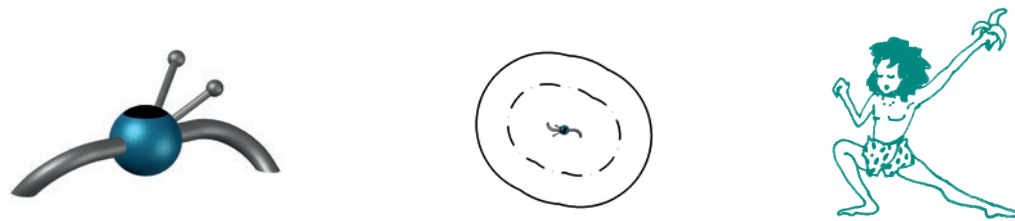

## Beetle.02

90.260.614.2

(m) 0,4 x 1,0 x 0,4  
("-") 1-4 x 3-2 x 1-4

EN 1176 (m) 2,4 x 3,0  
ASTM/CSA (m) 4,1 x 4,7  
ASTM/CSA ("-") 13-4 x 15-2

EN 1176 (m) 0,4  
ASTM/CSA ("-") 1-4



## Beetle.03

90.260.614.3

(m) 0,4 x 1,0 x 0,4  
("-") 1-4 x 3-2 x 1-4

EN 1176 (m) 2,4 x 3,0  
ASTM/CSA (m) 4,0 x 4,7  
ASTM/CSA ("-") 13-4 x 15-2

EN 1176 (m) 0,34  
ASTM/CSA ("-") 1-2

On Beetle.02 and Beetle.03, you can rock back and forth. The puristic design of the two play points allows plenty of room for imagination and adapts to any environment.



Beetle.02

Beetle.03

## Hula-Loop.01

90.260.930

(m) 1,1 x 0,6 x 0,5  
("-") 3-8 x 1-10 x 1-4

EN 1176 (m) 4,4 x 3,9  
ASTM/CSA (m) 4,6 x 5,1  
ASTM/CSA ("-") 14-10 x 16-8

EN 1176 (m) 0,41  
ASTM/CSA ("-") 1-4

Get the ball rolling! Whether alone or with others: the spring-loaded rubber bearing of the Hula-Loop lets you rotate your hips and challenges your balance. The two versions vary with the different ball tracks on the surface.



## Number.0

90.261.000

(m) 0,6 x 0,6 x 1,4  
("-") 2-0 x 2-0 x 4-8

EN 1176 (m) 3,2 x 3,2  
ASTM/CSA (m) 4,8 x 4,8  
ASTM/CSA ("-") 15-9 x 15-9

EN 1176 (m) 0,4  
ASTM/CSA ("-") 1-2

Our numbers are small, yet stylish rockers available in the shape of all the digits including a smart rocking mechanism that also withstands heavy rides.

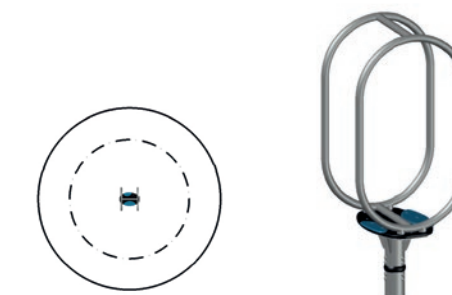



## Over Easy

90.260.615.1

m 0,9 x 0,9 x 0,6  
(") 2-9 x 2-9 x 1-11

EN 1176 (m) 3,9 x 3,9  
ASTM/CSA (m) 4,5 x 4,5  
ASTM/CSA (") 14-9 x 14-9

EN 1176 (m) 0,41  
ASTM/CSA (") 1-5

This Over Easy gives you the necessary swing. Whether playing with friends or rocking gently back and forth on your own. Also for small playground fans this wobble platform is a great alternative.



### Basic Colors of Ropes



Available for Standard 5/8" and 3/4" Rope

Only available for Standard 5/8" Rope



### Design Colors of Tubes and Posts (matte finish)

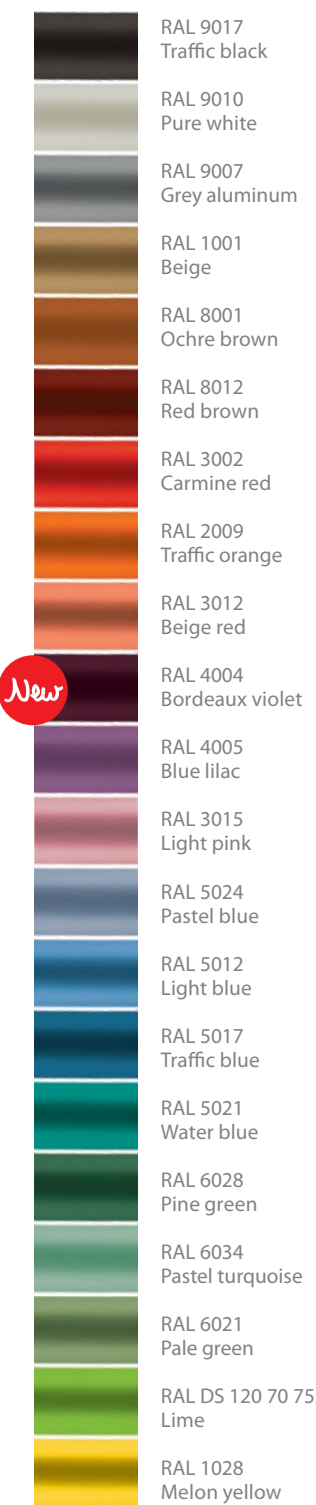

### Classic Colors of Tubes and Posts (glossy finish)

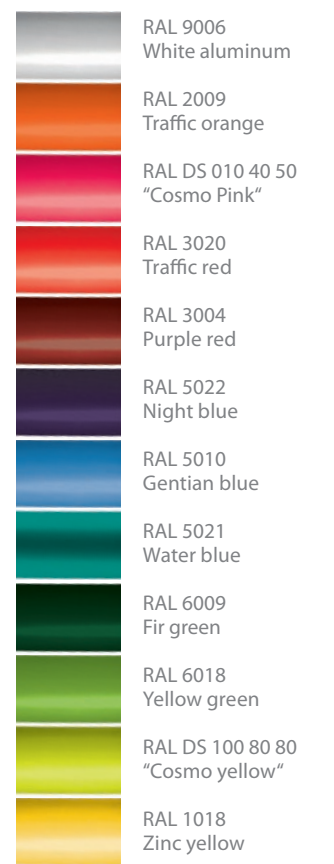

### Colors of HDPE-Panels (3/4")

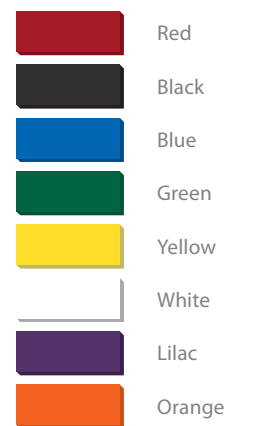

### Info

**Note:**  
All plan views within the catalog are shown with a scale of 1:200. Details of the product photos, technical plan views and 3D renderings may vary from the descriptions provided. All data is subject to technical changes and misprints. States requirements for age groups may vary, please check local guidelines.

## Product Name

## Item Number

(m) Dimensions (l x w x h)  
(") (")

EN 1176 (m) Minimum Space Required  
ASTM/CSA (m)  
ASTM/CSA (")

EN 1176 (m) Max. Fall Height  
ASTM/CSA (")



Berliner Seilfabrik  
Play Equipment Corporation  
96 Brookfield Oaks Drive  
Suite 140  
Greenville, SC 29607

T + 1 864 627 1092  
F + 1 864 627 1178

[info@berliner-playequipment.com](mailto:info@berliner-playequipment.com)  
[www.berliner-playequipment.com](http://www.berliner-playequipment.com)